

Short guide to main applications

| | Device | Application | Arcotronics SMD Film proposal | Main Competitors | SMD Film advantages |
|------------|--|--|-------------------------------|------------------|--|
| TELECOM | Mobile phone | A/D converter | LDB series | Ceramic NP0 | - Low Lock-up time - Narrow tolerance - No cracking |
| | | PLL filtering | | | |
| | Bluetooth ® | PLL filtering | LDB series | Ceramic NP0 | |
| | Modem | DMT modulation / demodulation | LDE / LDB series | Ceramic NP0 | |
| | Base station | Filtering | LDE / LDB series | Ceramic X7R | - High stability vs. frequency and temperature - High reliability - No cracking |
| | Line Card | Input filtering | LDE series | Ceramic NP0 | |
| Splitter | Filtering | LDE series | Ceramic X7R | | |
| AUTOMOTIVE | Wiper | Noise suppression | LDE series | Ceramic X7R | - High stability vs. frequency and temperature - High reliability - Low ESR - No cracking |
| | Driver information & car entertainment | Filtering, timing, coupling and decoupling | LDE series | Ceramic X7R | |
| | Tire pressure monitoring system | Resonant circuit | LDE series | Ceramic X7R | |
| CONSUMER | DC/DC converter | Input / output filtering | LDE series | Ceramic X7R | - High reliability - Low ESR - No cracking |
| | LCD Monitor | Inverter unit | LDE series | Ceramic X7R | - High stability vs. frequency and temperature - High reliability - No cracking |
| | DVD player | Filtering | LDB series | Ceramic NP0 | |
| | PDA | Inverter unit | LDB series | Ceramic NP0 | |
| | Hi-Fi systems | Filtering | LDE / LDB series | Ceramic X7R | |

Description:

- Non-encapsulated construction
- Stacked technology
- Metallized PEN (**P**oly**E**thylene **N**aphtalate) in LDE series
- Metallized PPS (**P**oly**P**henylene **S**ulfide) in LDB series
- RoHS 6 compliant (no hazardous materials)

Features:

- Excellent stability vs. temperature, frequency and time
- Self-healing
- High reliability
- Low ESR (**E**quivalent **S**eries **R**esistance)
- Typical failure mode at the end of life: open circuit
- No piezoelectric effect
- No cracking

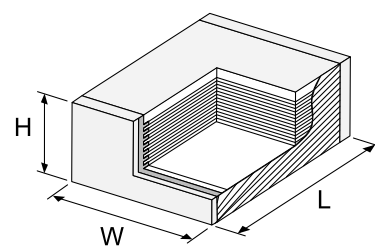

SMD Film Capacitors are complementary to MLCC for professional applications.

Product coding

LDE series - RoHS 6

The part number is composed of 15 digits:

| | | | | | | | | | | | | | | |
|---|---|---|---|---|---|---|---|---|----|----|----|----|----|----|
| 1 | 2 | 3 | 4 | 5 | 6 | 7 | 8 | 9 | 10 | 11 | 12 | 13 | 14 | 15 |
| L | D | E | - | - | - | - | - | - | A | - | - | - | - | 0 |

Digit 1 to 3 Series code.

Digit 4 D.C. rated voltage: (V_R)
 C = 50 V_{DC} D = 63 V_{DC} E = 100 V_{DC}
 I = 250 V_{DC} M = 400 V_{DC} P = 630 V_{DC}
 Q = 1000 V_{DC} (new version)

Digit 5 Size code (special sizes available upon special request)

| | | | | | | | |
|-------|-------|-------|-------|-------|-------|-------|-------|
| 12.06 | 12.10 | 18.12 | 22.20 | 28.24 | 40.30 | 50.40 | 60.54 |
| A | B | C | D | E | F | G | H |

Digit 6 to 9 Capacitance value
 Digits 7 - 8 - 9 indicate the first three numbers of the capacitance value, digit 6 indicates the number of zeros that must be added to obtain the rated capacitance in pF.

Digit 10 Capacitance tolerance
 Standard: K = $\pm 10\%$ M = $\pm 20\%$
 (J = $\pm 5\%$ available upon request and review of project/application)

Digit 11 Dielectric code
 A = PEN

Digit 12 Version
 5 = standard 0 = miniature A to Z = special

Digit 13 Packaging
 N = taped A to Z = special

Digit 14 Internal use

Digit 15 0 (used in LDE RoHS 6 series only)

LDB series - RoHS 6

The part number is composed of 14 digits:

| | | | | | | | | | | | | | |
|---|---|---|---|---|---|---|---|---|----|----|----|----|----|
| 1 | 2 | 3 | 4 | 5 | 6 | 7 | 8 | 9 | 10 | 11 | 12 | 13 | 14 |
| L | D | B | - | - | - | - | - | - | - | C | - | - | - |

Digit 1 to 3 Series code.

Digit 4 D.C. rated voltage: (V_R)
 A = 16 V_{DC}
 C = 50 V_{DC}

Digit 5 Size code

| | | |
|-------|-------|-------|
| 12.06 | 12.10 | 18.12 |
| A | B | C |

Digit 6 to 9 Capacitance value
 Digits 7 - 8 - 9 indicate the first three numbers of the capacitance value, digit 6 indicates the number of zeros that must be added to obtain the rated capacitance in pF.

Digit 10 Capacitance tolerance
 G = $\pm 2\%$ J = $\pm 5\%$

Digit 11 Dielectric code
 C = PPS

Digit 12 Version
 5 = standard A to Z = special

Digit 13 Packaging
 N = taped A to Z = special

Digit 14 Internal use

Product packaging

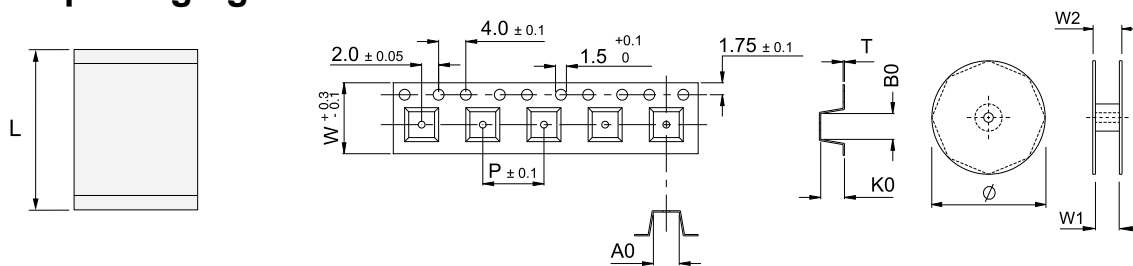

SMD Film Capacitor (top view)

Tape

Reel

| Size code | Carrier tape code | Carrier tape dimensions | | | | | Reel dimensions | | | Packaging quantities (pcs per reel) | |
|-----------|-------------------|-------------------------|---------|---------|--------|--------|-----------------|--------|---------|-------------------------------------|---------|
| | | A0 [mm] | B0 [mm] | K0 [mm] | W [mm] | P [mm] | T [µm] | Ø [mm] | W1 [mm] | | W2 [mm] |
| 12.06 | - | 2.00 | 3.80 | 1.30 | 8 | 4 | 250 | 180 | 8 | 12 | 3000 |
| 12.10 | - | 3.00 | 3.80 | 2.10 | 8 | 4 | 250 | 180 | 8 | 12 | 2250 |
| 18.12 | a | 3.80 | 5.30 | 2.00 | 12 | 8 | 300 | 330 | 12 | 16 | 4000 |
| | b | 3.90 | 5.20 | 2.60 | | | | | | | 3000 |
| 22.20 | a | 5.50 | 6.50 | 2.90 | 12 | 8 | 250 | 330 | 12 | 16 | 3000 |
| | b | | | 3.80 | | | | | | | 2250 |
| | c | | | 4.90 | | | | | | | 1750 |
| 28.24 | a | 6.60 | 7.90 | 3.80 | 16 | 8 | 300 | 330 | 16 | 20 | 2250 |
| | b | | | 4.60 | | | | | | | 1750 |
| | c | | | 5.50 | | | | | | | 1500 |
| 40.30 | a | 8.60 | 11.00 | 3.80 | 16 | 12 | 300 | 330 | 16 | 20 | 1500 |
| | b | | | 4.60 | | | | | | | 1250 |
| | c | | | 5.80 | | | | | | | 1000 |
| 50.40 | a | 10.90 | 13.50 | 3.80 | 24 | 12 | 250 | 330 | 24 | 28 | 1500 |
| | b | 10.90 | | 4.70 | | | | | | | 1250 |
| | c | 11.00 | | 5.90 | | | | | | | 1000 |
| 60.54 | a | 14.40 | 16.00 | 4.30 | 24 | 16 | 300 | 330 | 24 | 28 | 1000 |
| | b | | | 5.10 | | | | | | | 750 |
| | c | | | 5.80 | | | | | | | 750 |

In accordance with IEC 60286-3

Materials:

- carrier tape: antistatic material
- cover tape: polyester + polythene
- reel: recyclable polystyrene

All parts in reels are packed in hermetically sealed **Moisture Barrier Bag (MBB) Class 1.**

PEN and PPS dielectrics typical temperature graphs

PEN

Capacitance vs. temperature
(f = 1 kHz)

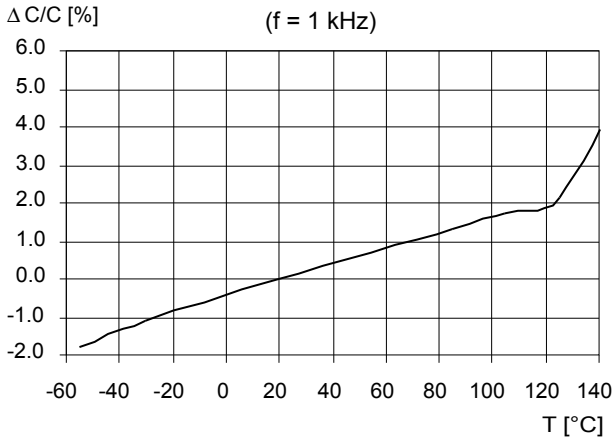

PPS

Capacitance vs. temperature
(f = 1 kHz)

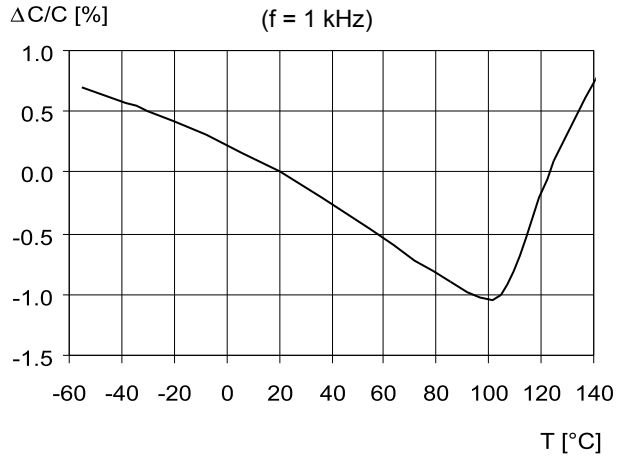

Dissipation factor vs. temperature
(f = 1 kHz)

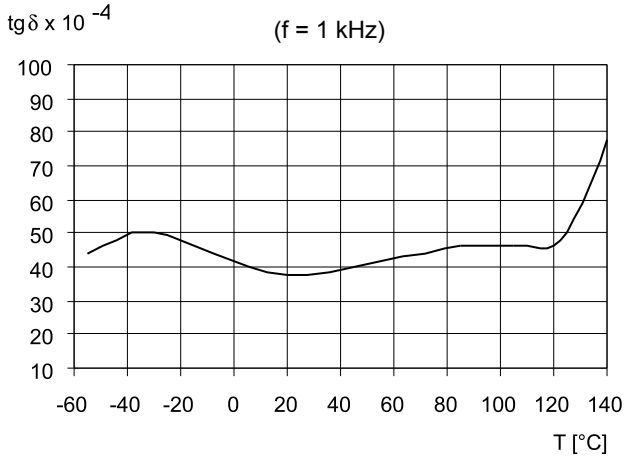

Dissipation factor vs. temperature
(f = 1 kHz)

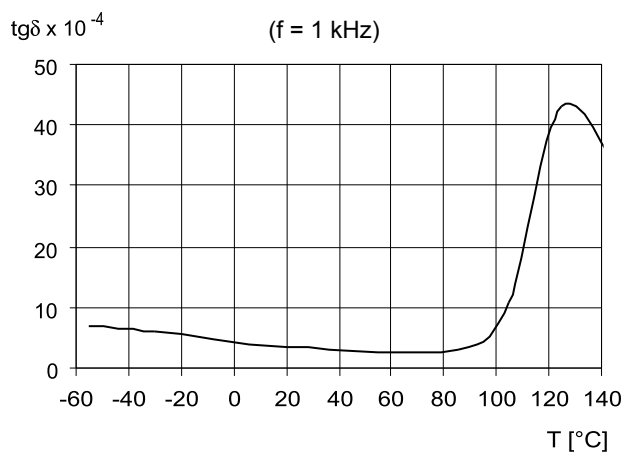

Insulation resistance vs. temperature

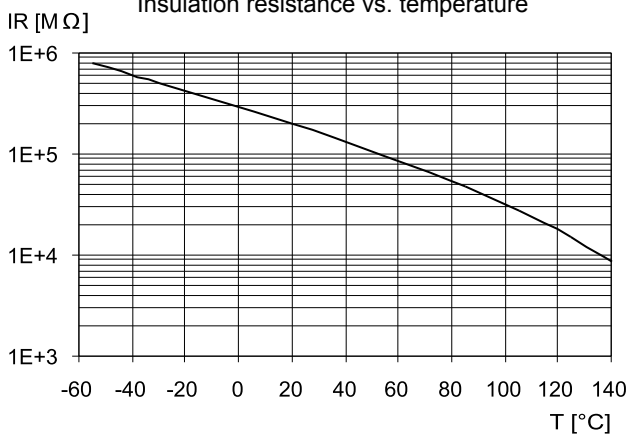

Insulation resistance vs. temperature

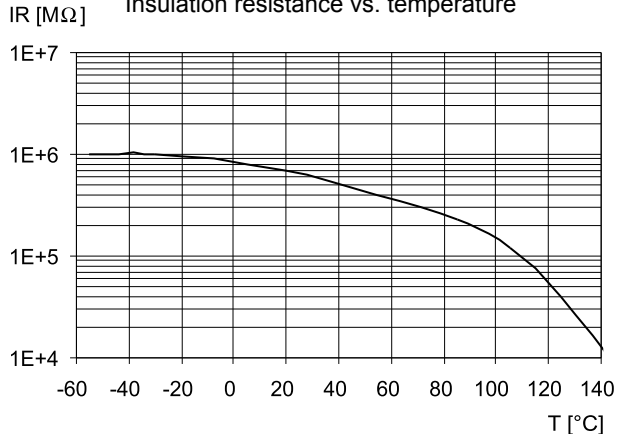

PEN and PPS dielectrics typical frequency graphs

PEN

PPS

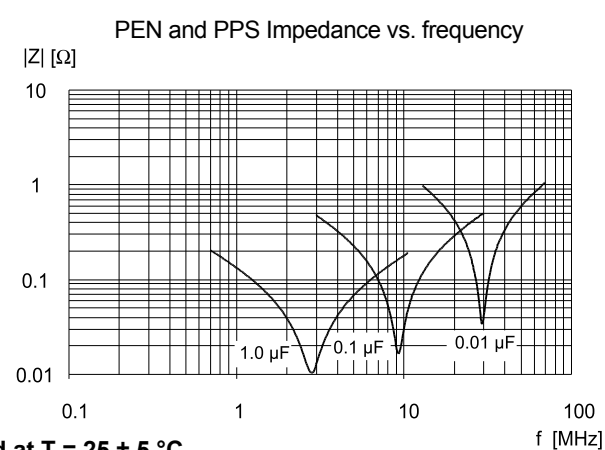
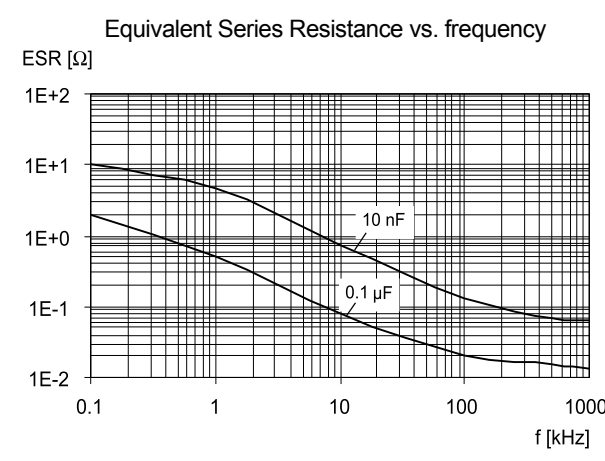
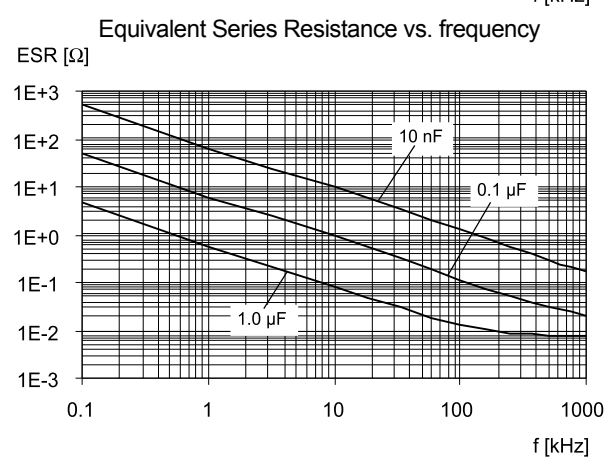
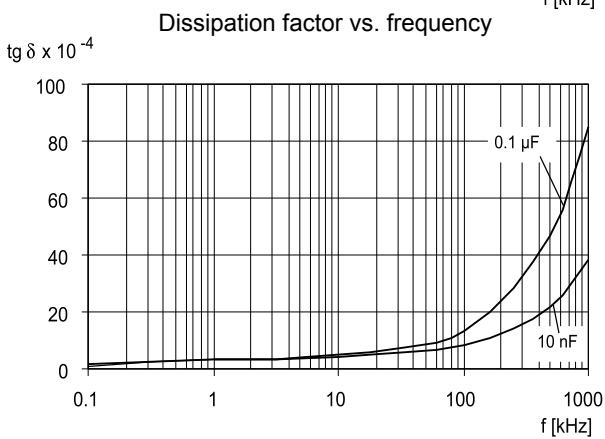
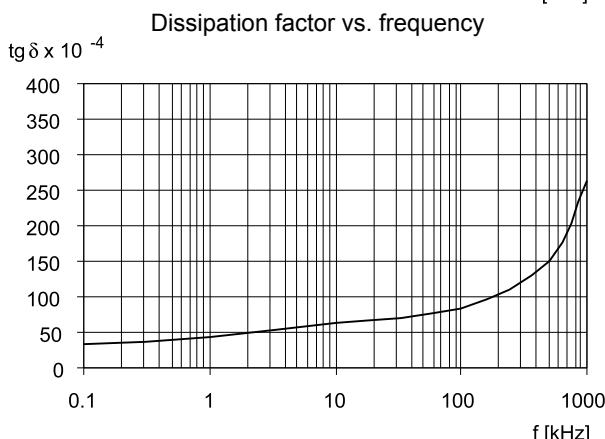
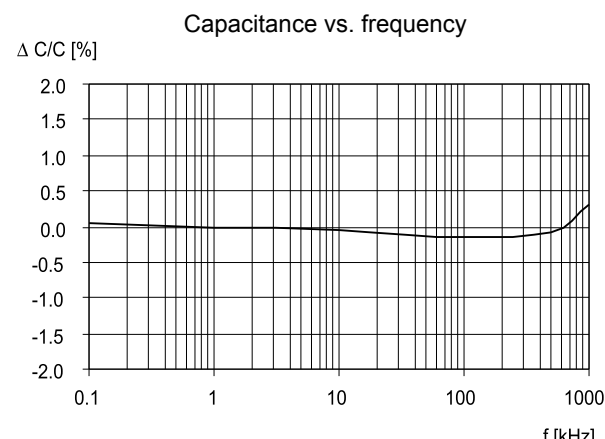
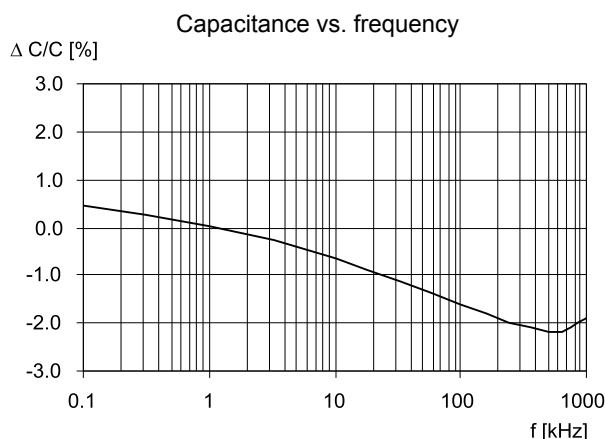

Note: measurements performed at T = 25 ± 5 °C



LDE Series - PEN dielectric RoHS 6

LOW VOLTAGE (capacitance range: 1000 pF to 0.047 μF)

Standard and miniature versions

| Rated cap. | 50 V _{DC} / 40 V _{AC} | | | | 63 V _{DC} / 40 V _{AC} | | | | 100 V _{DC} / 63 V _{AC} | | | | 250 V _{DC} / 120 V _{AC} | | | | Rated cap. |
|------------|---|--------------|-----------|-----------------------|---|--------------|-----------|-----------------------|--|--------------|-----------|----------------------|---|--------------|-----------|----------------------|------------|
| | Size code | Pcs per reel | Hmax [mm] | Part number | Size code | Pcs per reel | Hmax [mm] | Part number | Size code | Pcs per reel | Hmax [mm] | Part number | Size code | Pcs per reel | Hmax [mm] | Part number | |
| 1000 pF | 12.06 | 3000 | 1.1 | LDECA1100 - A0 - - 0 | 12.06 | 3000 | 1.1 | LDEDA1100 - A0 - - 0 | 12.06 | 3000 | 1.1 | LDEEA1100 - A0 - - 0 | 12.06 | 3000 | 1.1 | LDEIA1100 - A0 - - 0 | 1000 pF |
| 1200 pF | 12.06 | 3000 | 1.1 | LDECA1120 - A0 - - 0 | 12.06 | 3000 | 1.1 | LDEDA1120 - A0 - - 0 | 12.06 | 3000 | 1.1 | LDEEA1120 - A0 - - 0 | 12.06 | 3000 | 1.1 | LDEIA1120 - A0 - - 0 | 1200 pF |
| 1500 pF | 18.12 | 4000 | 1.7 | LDECC1150 - A5 - - 0 | 18.12 | 4000 | 1.7 | LDEDC1150 - A5 - - 0 | 18.12 | 4000 | 1.7 | LDEEC1150 - A5 - - 0 | 18.12 | 4000 | 1.7 | LDEIC1150 - A5 - - 0 | 1500 pF |
| | 12.06 | 3000 | 1.1 | LDECA1150 - A0 - - 0 | 12.06 | 3000 | 1.1 | LDEDA1150 - A0 - - 0 | 12.06 | 3000 | 1.1 | LDEEA1150 - A0 - - 0 | 12.06 | 3000 | 1.1 | LDEIA1150 - A0 - - 0 | |
| 1800 pF | 18.12 | 4000 | 1.7 | LDECC1180 - A5 - - 0 | 18.12 | 4000 | 1.7 | LDEDC1180 - A5 - - 0 | 18.12 | 4000 | 1.7 | LDEEC1180 - A5 - - 0 | 18.12 | 4000 | 1.7 | LDEIC1180 - A5 - - 0 | 1800 pF |
| | 12.06 | 3000 | 1.1 | LDECA1180 - A0 - - 0 | 12.06 | 3000 | 1.1 | LDEDA1180 - A0 - - 0 | 12.06 | 3000 | 1.1 | LDEEA1180 - A0 - - 0 | 12.06 | 3000 | 1.1 | LDEIA1180 - A0 - - 0 | |
| 2200 pF | 18.12 | 4000 | 1.7 | LDECC1220 - A5 - - 0 | 18.12 | 4000 | 1.7 | LDEDC1220 - A5 - - 0 | 18.12 | 4000 | 1.7 | LDEEC1220 - A5 - - 0 | 18.12 | 4000 | 1.7 | LDEIC1220 - A5 - - 0 | 2200 pF |
| | 12.06 | 3000 | 1.1 | LDECA1220 - A0 - - 0 | 12.06 | 3000 | 1.1 | LDEDA1220 - A0 - - 0 | 12.06 | 3000 | 1.1 | LDEEA1220 - A0 - - 0 | 12.06 | 3000 | 1.1 | LDEIA1220 - A0 - - 0 | |
| 2700 pF | 18.12 | 4000 | 1.8 | LDECC1270 - A5 - - 0 | 18.12 | 4000 | 1.8 | LDEDC1270 - A5 - - 0 | 18.12 | 4000 | 1.8 | LDEEC1270 - A5 - - 0 | 18.12 | 4000 | 1.8 | LDEIC1270 - A5 - - 0 | 2700 pF |
| | 12.06 | 3000 | 1.1 | LDECA1270 - A0 - - 0 | 12.06 | 3000 | 1.1 | LDEDA1270 - A0 - - 0 | 12.06 | 3000 | 1.1 | LDEEA1270 - A0 - - 0 | 12.06 | 3000 | 1.1 | LDEIA1270 - A0 - - 0 | |
| 3300 pF | 18.12 | 4000 | 1.7 | LDECC1330 - A5 - - 0 | 18.12 | 4000 | 1.7 | LDEDC1330 - A5 - - 0 | 18.12 | 4000 | 1.7 | LDEEC1330 - A5 - - 0 | 18.12 | 4000 | 1.7 | LDEIC1330 - A5 - - 0 | 3300 pF |
| | 12.06 | 3000 | 1.2 | LDECA1330 - A0 - - 0 | 12.06 | 3000 | 1.2 | LDEDA1330 - A0 - - 0 | 12.06 | 3000 | 1.2 | LDEEA1330 - A0 - - 0 | 12.06 | 3000 | 1.2 | LDEIA1330 - A0 - - 0 | |
| 3900 pF | 18.12 | 4000 | 1.7 | LDECC1390 - A5 - - 0 | 18.12 | 4000 | 1.7 | LDEDC1390 - A5 - - 0 | 18.12 | 4000 | 1.7 | LDEEC1390 - A5 - - 0 | 18.12 | 4000 | 1.7 | LDEIC1390 - A5 - - 0 | 3900 pF |
| | 12.06 | 3000 | 1.1 | LDECA1390 - A0 - - 0 | 12.06 | 3000 | 1.1 | LDEDA1390 - A0 - - 0 | 12.06 | 3000 | 1.1 | LDEEA1390 - A0 - - 0 | 12.10 | 2250 | 1.6 | LDEIB1390 - A0 - - 0 | |
| 4700 pF | 18.12 | 4000 | 1.8 | LDECC1470 - A5 - - 0 | 18.12 | 4000 | 1.8 | LDEDC1470 - A5 - - 0 | 18.12 | 4000 | 1.8 | LDEEC1470 - A5 - - 0 | 18.12 | 4000 | 1.8 | LDEIC1470 - A5 - - 0 | 4700 pF |
| | 12.06 | 3000 | 1.1 | LDECA1470 - A0 - - 0 | 12.06 | 3000 | 1.1 | LDEDA1470 - A0 - - 0 | 12.06 | 3000 | 1.1 | LDEEA1470 - A0 - - 0 | 12.10 | 2250 | 1.6 | LDEIB1470 - A0 - - 0 | |
| 5600 pF | 18.12 | 4000 | 1.7 | LDECC1560 - A5 - - 0 | 18.12 | 4000 | 1.7 | LDEDC1560 - A5 - - 0 | 18.12 | 4000 | 1.7 | LDEEC1560 - A5 - - 0 | 18.12 | 4000 | 1.7 | LDEIC1560 - A5 - - 0 | 5600 pF |
| | 12.06 | 3000 | 1.1 | LDECA1560 - A0 - - 0 | 12.06 | 3000 | 1.1 | LDEDA1560 - A0 - - 0 | 12.06 | 3000 | 1.1 | LDEEA1560 - A0 - - 0 | 12.10 | 2250 | 1.6 | LDEIB1560 - A0 - - 0 | |
| 6800 pF | 18.12 | 4000 | 1.7 | LDECC1680 - A5 - - 0 | 18.12 | 4000 | 1.7 | LDEDC1680 - A5 - - 0 | 18.12 | 4000 | 1.7 | LDEEC1680 - A5 - - 0 | 18.12 | 4000 | 1.7 | LDEIC1680 - A5 - - 0 | 6800 pF |
| | 12.06 | 3000 | 1.1 | LDECA1680 - A0 - - 0 | 12.06 | 3000 | 1.1 | LDEDA1680 - A0 - - 0 | 12.06 | 3000 | 1.1 | LDEEA1680 - A0 - - 0 | 12.10 | 2250 | 1.8 | LDEIB1680 - A0 - - 0 | |
| 8200 pF | 18.12 | 4000 | 1.8 | LDECC1820 - A5 - - 0 | 18.12 | 4000 | 1.8 | LDEDC1820 - A5 - - 0 | 18.12 | 4000 | 1.8 | LDEEC1820 - A5 - - 0 | 18.12 | 4000 | 1.8 | LDEIC1820 - A5 - - 0 | 8200 pF |
| | 12.06 | 3000 | 1.1 | LDECA1820 - A0 - - 0 | 12.06 | 3000 | 1.1 | LDEDA1820 - A0 - - 0 | 12.06 | 3000 | 1.1 | LDEEA1820 - A0 - - 0 | 12.10 | 2250 | 2.0 | LDEIB1820 - A0 - - 0 | |
| 0.010 μF | 18.12 | 4000 | 1.7 | LDECC2100 - A5 - - 0 | 18.12 | 4000 | 1.7 | LDEDC2100 - A5 - - 0 | 18.12 | 4000 | 1.7 | LDEEC2100 - A5 - - 0 | 18.12 | 4000 | 1.7 | LDEIC2100 - A5 - - 0 | 0.010 μF |
| | 12.06 | 3000 | 1.1 | LDECA2100 - A0 - - 0 | 12.06 | 3000 | 1.1 | LDEDA2100 - A0 - - 0 | 12.06 | 3000 | 1.1 | LDEEA2100 - A0 - - 0 | 12.10 | 2250 | 2.1 | LDEIB2100 - A0 - - 0 | |
| 0.012 μF | 18.12 | 4000 | 1.7 | LDECC2120 - A5 - - 0 | 18.12 | 4000 | 1.7 | LDEDC2120 - A5 - - 0 | 18.12 | 4000 | 1.7 | LDEEC2120 - A5 - - 0 | 18.12 | 4000 | 1.7 | LDEIC2120 - A5 - - 0 | 0.012 μF |
| | 12.06 | 3000 | 1.1 | LDECA2120 - A0 - - 0 | 12.06 | 3000 | 1.1 | LDEDA2120 - A0 - - 0 | 12.06 | 3000 | 1.1 | LDEEA2120 - A0 - - 0 | | | | | |
| 0.015 μF | 18.12 | 4000 | 1.7 | LDECC2150 - A5 - - 0 | 18.12 | 4000 | 1.7 | LDEDC2150 - A5 - - 0 | 18.12 | 4000 | 1.7 | LDEEC2150 - A5 - - 0 | 18.12 | 4000 | 1.7 | LDEIC2150 - A5 - - 0 | 0.015 μF |
| | 12.06 | 3000 | 1.2 | LDECA2150 - A0 - - 0 | 12.06 | 3000 | 1.2 | LDEDA2150 - A0 - - 0 | 12.06 | 3000 | 1.2 | LDEEA2150 - A0 - - 0 | | | | | |
| 0.018 μF | 18.12 | 4000 | 1.8 | LDECC2180 - A5 - - 0 | 18.12 | 4000 | 1.8 | LDEDC2180 - A5 - - 0 | 18.12 | 4000 | 1.8 | LDEEC2180 - A5 - - 0 | 22.20 | 3000 | 2.2 | LDEID2180 - A5 - - 0 | 0.018 μF |
| | 12.06 | 3000 | 1.1 | LDECA2180 - A0 - - 0 | 12.06 | 3000 | 1.1 | LDEDA2180 - A0 - - 0 | 12.10 | 2250 | 1.5 | LDEEB2180 - A0 - - 0 | 18.12 | 4000 | 1.8 | LDEIC2180 - A0 - - 0 | |
| 0.022 μF | 18.12 | 4000 | 1.7 | LDECC2220 - A5 - - 0 | 18.12 | 4000 | 1.7 | LDEDC2220 - A5 - - 0 | 18.12 | 4000 | 1.7 | LDEEC2220 - A5 - - 0 | 22.20 | 3000 | 2.5 | LDEID2220 - A5 - - 0 | 0.022 μF |
| | 12.06 | 3000 | 1.1 | LDECA2220 - A0 - - 0 | 12.06 | 3000 | 1.1 | LDEDA2220 - A0 - - 0 | 12.10 | 2250 | 1.5 | LDEEB2220 - A0 - - 0 | 18.12 | 3000 | 2.2 | LDEIC2220 - A0 - - 0 | |
| 0.027 μF | 18.12 | 4000 | 1.7 | LDECC2270 - A5 - - 0 | 18.12 | 4000 | 1.7 | LDEDC2270 - A5 - - 0 | 18.12 | 4000 | 1.7 | LDEEC2270 - A5 - - 0 | 22.20 | 2250 | 2.9 | LDEID2270 - A5 - - 0 | 0.027 μF |
| | 12.06 | 3000 | 1.1 | LDECA2270 - A0 - - 0 | 12.06 | 3000 | 1.1 | LDEDA2270 - A0 - - 0 | 12.10 | 2250 | 1.7 | LDEEB2270 - A0 - - 0 | 18.12 | 3000 | 2.5 | LDEIC2270 - A0 - - 0 | |
| 0.033 μF | 18.12 | 4000 | 1.8 | LDECC2330 - A5 - - 0 | 18.12 | 4000 | 1.8 | LDEDC2330 - A5 - - 0 | 18.12 | 4000 | 1.8 | LDEEC2330 - A5 - - 0 | 22.20 | 3000 | 1.9 | LDEID2330 - A5 - - 0 | 0.033 μF |
| | 12.06 | 2250 | 2.0 | LDECB2330 - A0 - - 0 | 12.10 | 2250 | 2.0 | LDEDB2330 - A0 - - 0 | 12.10 | 2250 | 2.0 | LDEEB2330 - A0 - - 0 | 18.12 | 3000 | 2.6 | LDEIC2330 - A0 - - 0 | |
| 0.039 μF | 18.12 | 4000 | 1.2 | *LDECA2330 - A0 - - 0 | 12.06 | 3000 | 1.2 | *LDEDA2330 - A0 - - 0 | | | | | | | | | 0.039 μF |
| | 18.12 | 4000 | 1.7 | LDECC2390 - A5 - - 0 | 18.12 | 4000 | 1.7 | LDEDC2390 - A5 - - 0 | 18.12 | 4000 | 1.7 | LDEEC2390 - A5 - - 0 | 22.20 | 3000 | 2.1 | LDEID2390 - A5 - - 0 | |
| 0.047 μF | 12.10 | 2250 | 2.1 | LDECB2390 - A0 - - 0 | 12.10 | 2250 | 2.1 | LDEDB2390 - A0 - - 0 | 12.10 | 2250 | 2.1 | LDEEB2390 - A0 - - 0 | | | | | 0.047 μF |
| | 18.12 | 4000 | 1.7 | LDECC2470 - A5 - - 0 | 18.12 | 4000 | 1.7 | LDEDC2470 - A5 - - 0 | 18.12 | 4000 | 1.7 | LDEEC2470 - A5 - - 0 | 22.20 | 3000 | 2.3 | LDEID2470 - A5 - - 0 | |
| | 12.10 | 2250 | 2.1 | LDECB2470 - A0 - - 0 | 12.10 | 2250 | 2.1 | LDEDB2470 - A0 - - 0 | 12.10 | 2250 | 2.1 | LDEEB2470 - A0 - - 0 | | | | | |

Tolerance - Standard: K = ±10%; M = ±20%;
 (J = ±5% available upon request and review of project/application)
 Packaging - N = Taped; A to Z = Special;
 Internal use

* only K and M tolerances available

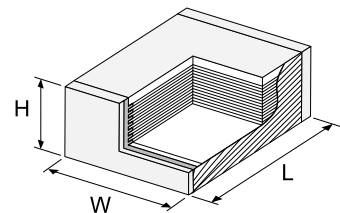

| Size code | 12.06 | 12.10 | 18.12 | 22.20 | 28.24 | 40.30 | 50.40 | 60.54 |
|-----------|-------------------------------------|-------------------------------------|-------------------------------------|-----------|-----------|------------|------------|------------|
| L (mm) | 3.3 ^{+0.3} _{-0.1} | 3.3 ^{+0.3} _{-0.1} | 4.7 ^{+0.3} _{-0.2} | 6.0 ± 0.3 | 7.3 ± 0.4 | 10.5 ± 0.4 | 13.0 ± 0.4 | 15.5 ± 0.4 |
| W (mm) | 1.7 ± 0.2 | 2.5 ± 0.3 | 3.3 ± 0.3 | 5.0 ± 0.4 | 6.1 ± 0.4 | 7.9 ± 0.5 | 10.4 ± 0.5 | 13.7 ± 0.5 |

LDE Series - PEN dielectric RoHS 6



LOW VOLTAGE (capacitance range: 0.056 µF to 4.7 µF)

Standard and miniature versions

| Rated cap. | 50 V _{DC} / 40 V _{AC} | | | | 63 V _{DC} / 40 V _{AC} | | | | 100 V _{DC} / 63 V _{AC} | | | | 250 V _{DC} / 120 V _{AC} | | | | Rated cap. |
|------------|---|--------------|-----------|----------------------|---|--------------|-----------|----------------------|--|--------------|-----------|-----------------------|---|--------------|-----------|----------------------|------------|
| | Size code | Pcs per reel | Hmax [mm] | Part number | Size code | Pcs per reel | Hmax [mm] | Part number | Size code | Pcs per reel | Hmax [mm] | Part number | Size code | Pcs per reel | Hmax [mm] | Part number | |
| 0.056 µF | 18.12 | 4000 | 1.7 | LDECC2560 - A5 - - 0 | 18.12 | 4000 | 1.7 | LDEDC2560 - A5 - - 0 | 18.12 | 4000 | 1.7 | LDEEC2560 - A5 - - 0 | 22.20 | 3000 | 2.6 | LDEID2560 - A5 - - 0 | 0.056 µF |
| | 12.10 | 2250 | 1.7 | LDECB2560 - A0 - - 0 | 12.10 | 2250 | 1.7 | LDEDB2560 - A0 - - 0 | | | | | | | | | |
| 0.068 µF | 18.12 | 4000 | 1.8 | LDECC2680 - A5 - - 0 | 18.12 | 4000 | 1.8 | LDEDC2680 - A5 - - 0 | 18.12 | 4000 | 1.8 | LDEEC2680 - A5 - - 0 | 22.20 | 3000 | 2.8 | LDEID2680 - A5 - - 0 | 0.068 µF |
| | 12.10 | 2250 | 2.0 | LDECB2680 - A0 - - 0 | 12.10 | 2250 | 2.0 | LDEDB2680 - A0 - - 0 | | | | | | | | | |
| 0.082 µF | 18.12 | 3000 | 2.1 | LDECC2820 - A5 - - 0 | 18.12 | 3000 | 2.1 | LDEDC2820 - A5 - - 0 | 18.12 | 3000 | 2.1 | LDEEC2820 - A5 - - 0 | 28.24 | 2250 | 2.6 | LDEIE2820 - A5 - - 0 | 0.082 µF |
| | 12.10 | 2250 | 2.1 | LDECB2820 - A0 - - 0 | 12.10 | 2250 | 2.1 | LDEDB2820 - A0 - - 0 | | | | | 22.20 | 2250 | 3.5 | LDEID2820 - A0 - - 0 | |
| 0.10 µF | 18.12 | 3000 | 2.4 | LDECC3100 - A5 - - 0 | 18.12 | 3000 | 2.4 | LDEDC3100 - A5 - - 0 | 18.12 | 3000 | 2.4 | LDEEC3100 - A5 - - 0 | 28.24 | 2250 | 2.9 | LDEIE3100 - A5 - - 0 | 0.10 µF |
| | 12.10 | 2250 | 2.1 | LDECB3100 - A0 - - 0 | 12.10 | 2250 | 2.1 | LDEDB3100 - A0 - - 0 | | | | | 22.20 | 1750 | 4.1 | LDEID3100 - A0 - - 0 | |
| 0.12 µF | 18.12 | 4000 | 1.7 | LDECC3120 - A5 - - 0 | 18.12 | 4000 | 1.7 | LDEDC3120 - A5 - - 0 | 22.20 | 3000 | 2.6 | LDEED3120 - A5 - - 0 | 22.20 | 2250 | 3.3 | LDEIE3120 - A5 - - 0 | 0.12 µF |
| | | | | | | | | | | | | | 28.24 | 1750 | 4.4 | LDEID3120 - A0 - - 0 | |
| 0.15 µF | 18.12 | 4000 | 1.9 | LDECC3150 - A5 - - 0 | 18.12 | 4000 | 1.9 | LDEDC3150 - A5 - - 0 | 22.20 | 3000 | 1.9 | LDEED3150 - A5 - - 0 | 28.24 | 1750 | 3.8 | LDEIE3150 - A5 - - 0 | 0.15 µF |
| | 18.12 | 3000 | 2.2 | LDECC3180 - A5 - - 0 | 18.12 | 3000 | 2.2 | LDEDC3180 - A5 - - 0 | 22.20 | 3000 | 2.0 | LDEED3180 - A5 - - 0 | 40.30 | 1500 | 2.7 | LDEIF3180 - A5 - - 0 | |
| 0.18 µF | | | | | | | | | | | | | 28.24 | 1750 | 4.4 | LDEIE3180 - A0 - - 0 | 0.18 µF |
| | | | | | | | | | | | | | | | | | |
| 0.22 µF | 18.12 | 3000 | 2.4 | LDECC3220 - A5 - - 0 | 18.12 | 3000 | 2.4 | LDEDC3220 - A5 - - 0 | 22.20 | 3000 | 2.4 | LDEED3220 - A5 - - 0 | 40.30 | 1500 | 3.1 | LDEIF3220 - A5 - - 0 | 0.22 µF |
| | | | | | | | | | | | | | 28.24 | 1500 | 5.2 | LDEIE3220 - A0 - - 0 | |
| 0.27 µF | 22.20 | 3000 | 1.9 | LDECD3270 - A5 - - 0 | 22.20 | 3000 | 1.9 | LDEDD3270 - A5 - - 0 | 22.20 | 3000 | 2.8 | LDEED3270 - A5 - - 0 | 40.30 | 1500 | 3.7 | LDEIF3270 - A5 - - 0 | 0.27 µF |
| 0.33 µF | 22.20 | 3000 | 1.9 | LDECD3330 - A5 - - 0 | 22.20 | 3000 | 1.9 | LDEDD3330 - A5 - - 0 | 22.20 | 2250 | 3.3 | LDEED3330 - A5 - - 0 | 40.30 | 1250 | 4.3 | LDEIF3330 - A5 - - 0 | 0.33 µF |
| | 22.20 | 3000 | 2.1 | LDECD3390 - A5 - - 0 | 22.20 | 3000 | 2.1 | LDEDD3390 - A5 - - 0 | 28.24 | 2250 | 2.6 | LDEEE3390 - A5 - - 0 | 50.40 | 1500 | 3.3 | LDEIG3390 - A5 - - 0 | |
| 0.39 µF | | | | | | | | | 22.20 | 2250 | 3.7 | LDEED3390 - A0 - - 0 | 40.30 | 1000 | 5.0 | LDEIF3390 - A0 - - 0 | 0.39 µF |
| | | | | | | | | | 28.24 | 2250 | 3.0 | LDEEE3470 - A5 - - 0 | 50.40 | 1250 | 3.8 | LDEIG3470 - A5 - - 0 | |
| 0.47 µF | 22.20 | 3000 | 2.4 | LDECD3470 - A5 - - 0 | 22.20 | 3000 | 2.4 | LDEDD3470 - A5 - - 0 | 28.24 | 2250 | 3.0 | LDEEE3470 - A5 - - 0 | 50.40 | 1250 | 3.8 | LDEIG3470 - A5 - - 0 | 0.47 µF |
| | | | | | | | | | 22.20 | 1750 | 4.4 | LDEED3470 - A0 - - 0 | 40.30 | 1000 | 5.5 | LDEIF3470 - A0 - - 0 | |
| 0.56 µF | 22.20 | 3000 | 2.8 | LDECD3560 - A5 - - 0 | 22.20 | 3000 | 2.8 | LDEDD3560 - A5 - - 0 | 28.24 | 2250 | 3.5 | LDEEE3560 - A5 - - 0 | 50.40 | 1250 | 4.4 | LDEIG3560 - A5 - - 0 | 0.56 µF |
| | | | | | | | | | | | | | 40.30 | 1000 | 5.5 | LDEIF3560 M A0 - - 0 | |
| 0.68 µF | 22.20 | 2250 | 3.3 | LDECD3680 - A5 - - 0 | 22.20 | 2250 | 3.3 | LDEDD3680 - A5 - - 0 | 28.24 | 1750 | 4.1 | LDEEE3680 - A5 - - 0 | 60.54 | 1000 | 3.4 | LDEIH3680 - A5 - - 0 | 0.68 µF |
| | | | | | | | | | | | | | 50.40 | 1000 | 5.2 | LDEIG3680 - A0 - - 0 | |
| 0.82 µF | 28.24 | 2250 | 2.9 | LDECE3820 - A5 - - 0 | 28.24 | 2250 | 2.9 | LDEDE3820 - A5 - - 0 | 40.30 | 1500 | 2.8 | LDEEF3820 - A5 - - 0 | 60.54 | 1000 | 3.9 | LDEIH3820 - A5 - - 0 | 0.82 µF |
| | 22.20 | 1750 | 3.7 | LDECD3820 - A0 - - 0 | 22.20 | 2250 | 3.7 | LDEDD3820 - A0 - - 0 | 28.24 | 1500 | 4.9 | LDEEE3820 - A0 - - 0 | 50.40 | 1000 | 5.7 | LDEIG3820 - A0 - - 0 | |
| 1.0 µF | 28.24 | 2250 | 3.1 | LDECE4100 - A5 - - 0 | 28.24 | 2250 | 3.1 | LDEDE4100 - A5 - - 0 | 40.30 | 1500 | 3.2 | LDEEF4100 - A5 - - 0 | 60.54 | 750 | 4.6 | LDEIH4100 - A5 - - 0 | 1.0 µF |
| | 22.20 | 1750 | 4.4 | LDECD4100 - A0 - - 0 | 22.20 | 1750 | 4.4 | LDEDD4100 - A0 - - 0 | 28.24 | 1500 | 5.4 | *LDEEE4100 - A0 - - 0 | | | | | |
| 1.2 µF | 28.24 | 2250 | 3.6 | LDECE4120 - A5 - - 0 | 28.24 | 2250 | 3.6 | LDEDE4120 - A5 - - 0 | 50.40 | 1500 | 3.1 | LDEEG4120 - A5 - - 0 | 60.54 | 750 | 5.4 | LDEIH4120 - A0 - - 0 | 1.2 µF |
| | | | | | | | | | 40.30 | 1500 | 3.7 | LDEEF4120 - A0 - - 0 | | | | | |
| 1.5 µF | 50.40 | 1500 | 3.1 | LDECG4150 - A5 - - 0 | 50.40 | 1500 | 3.1 | LDEDG4150 - A5 - - 0 | 50.40 | 1500 | 3.1 | LDEEG4150 - A5 - - 0 | 60.54 | 750 | 5.7 | LDEIH4150 M A0 - - 0 | 1.5 µF |
| | 28.24 | 1750 | 4.3 | LDECE4150 - A0 - - 0 | 28.24 | 1750 | 4.3 | LDEDE4150 - A0 - - 0 | 40.30 | 1250 | 4.5 | LDEEF4150 - A0 - - 0 | | | | | |
| 1.8 µF | 50.40 | 1500 | 3.4 | LDECG4180 - A5 - - 0 | 50.40 | 1500 | 3.4 | LDEDG4180 - A5 - - 0 | 50.40 | 1500 | 3.4 | LDEEG4180 - A5 - - 0 | | | | | 1.8 µF |
| | 28.24 | 1500 | 5.1 | LDECE4180 - A0 - - 0 | 28.24 | 1500 | 5.1 | LDEDE4180 - A0 - - 0 | 40.30 | 1000 | 5.4 | LDEEF4180 - A0 - - 0 | | | | | |
| 2.2 µF | 50.40 | 1250 | 4.1 | LDECG4220 - A5 - - 0 | 50.40 | 1250 | 4.1 | LDEDG4220 - A5 - - 0 | 50.40 | 1250 | 4.1 | LDEEG4220 - A5 - - 0 | | | | | 2.2 µF |
| | 40.30 | 1500 | 3.3 | LDECF4220 - A0 - - 0 | 40.30 | 1500 | 3.3 | LDEDF4220 - A0 - - 0 | 40.30 | 1000 | 5.6 | *LDEEF4220 - A0 - - 0 | | | | | |
| 2.7 µF | 50.40 | 1000 | 4.9 | LDECG4270 - A5 - - 0 | 50.40 | 1000 | 4.9 | LDEDG4270 - A5 - - 0 | 60.54 | 1000 | 3.3 | LDEEH4270 - A5 - - 0 | | | | | 2.7 µF |
| | 40.30 | 1250 | 4.0 | LDECF4270 - A0 - - 0 | 40.30 | 1250 | 4.0 | LDEDF4270 - A0 - - 0 | 50.40 | 1000 | 4.9 | LDEEG4270 - A0 - - 0 | | | | | |
| 3.3 µF | 60.54 | 1000 | 3.9 | LDECH4330 - A5 - - 0 | 60.54 | 1000 | 3.9 | LDEDH4330 - A5 - - 0 | 60.54 | 1000 | 3.9 | LDEEH4330 - A5 - - 0 | | | | | 3.3 µF |
| | 40.30 | 1000 | 4.7 | LDECF4330 - A0 - - 0 | 40.30 | 1000 | 4.7 | LDEDF4330 - A0 - - 0 | 50.40 | 1000 | 5.7 | LDEEG4330 - A0 - - 0 | | | | | |
| 3.9 µF | 60.54 | 750 | 4.5 | LDECH4390 - A5 - - 0 | 60.54 | 750 | 4.5 | LDEDH4390 - A5 - - 0 | 60.54 | 750 | 4.5 | LDEEH4390 - A5 - - 0 | | | | | 3.9 µF |
| | 40.30 | 1000 | 5.5 | LDECF4390 - A0 - - 0 | 40.30 | 1000 | 5.5 | LDEDF4390 - A0 - - 0 | | | | | | | | | |
| 4.7 µF | 60.54 | 750 | 5.3 | LDECH4470 - A5 - - 0 | 60.54 | 750 | 5.3 | LDEDH4470 - A5 - - 0 | 60.54 | 750 | 5.3 | LDEEH4470 - A5 - - 0 | | | | | 4.7 µF |
| | 50.40 | 1250 | 4.1 | LDECG4470 - A0 - - 0 | 50.40 | 1250 | 4.1 | LDEDG4470 - A0 - - 0 | | | | | | | | | |

Tolerance - Standard: K = ±10%; M = ±20%; _____
 (J = ±5% available upon request and review of project/application)
 Packaging - N = Taped; A to Z = Special; _____
 Internal use _____

* only K and M tolerances available

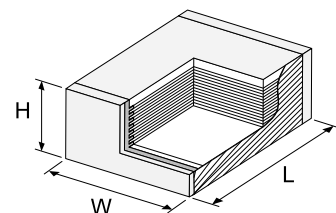

| Size code | 12.10 | 18.12 | 22.20 | 28.24 | 40.30 | 50.40 | 60.54 |
|-----------|-------------------------------------|-------------------------------------|-----------|-----------|------------|------------|------------|
| L (mm) | 3.3 ^{+0.3} _{-0.1} | 4.7 ^{+0.3} _{-0.2} | 6.0 ± 0.3 | 7.3 ± 0.4 | 10.5 ± 0.4 | 13.0 ± 0.4 | 15.5 ± 0.4 |
| W (mm) | 2.5 ± 0.3 | 3.3 ± 0.3 | 5.0 ± 0.4 | 6.1 ± 0.4 | 7.9 ± 0.5 | 10.4 ± 0.5 | 13.7 ± 0.5 |



LDE SERIES - PEN dielectric RoHS 6

HIGH VOLTAGE (capacitance range: 1000 pF to 0.47 μF)

Standard and miniature versions

| Rated cap. | 400 V _{DC} / 160 V _{AC} | | | | 630 V _{DC} / 200 V _{AC} | | | | 1000 V _{DC} / 250 V _{AC} | | | | Rated cap. |
|------------|---|--------------|-----------------------|---------------------|---|--------------|-----------------------|----------------------|--|--------------|-----------------------|---------------------|------------|
| | Size code | Pcs per reel | H _{max} [mm] | Part number | Size code | Pcs per reel | H _{max} [mm] | Part number | Size code | Pcs per reel | H _{max} [mm] | Part number | |
| 1000 pF | | | | | 22.20 | 3000 | 1.9 | LDEPD1100 - A5 -- 0 | 22.20 | 3000 | 1.9 | LDEQD1100 - A5 -- 0 | 1000 pF |
| 1200 pF | | | | | 22.20 | 3000 | 2.0 | LDEPD1120 - A5 -- 0 | 22.20 | 3000 | 2.0 | LDEQD1120 - A5 -- 0 | 1200 pF |
| 1500 pF | | | | | 22.20 | 3000 | 2.3 | LDEPD1150 - A5 -- 0 | 22.20 | 3000 | 2.3 | LDEQD1150 - A5 -- 0 | 1500 pF |
| 1800 pF | | | | | 22.20 | 3000 | 2.5 | LDEPD1180 - A5 -- 0 | 22.20 | 3000 | 2.5 | LDEQD1180 - A5 -- 0 | 1800 pF |
| 2200 pF | | | | | 22.20 | 3000 | 2.0 | LDEPD1220 - A5 -- 0 | 22.20 | 3000 | 2.0 | LDEQD1220 - A5 -- 0 | 2200 pF |
| 2700 pF | | | | | 22.20 | 3000 | 2.3 | LDEPD1270 - A5 -- 0 | 22.20 | 3000 | 2.3 | LDEQD1270 - A5 -- 0 | 2700 pF |
| 3300 pF | | | | | 22.20 | 3000 | 2.6 | LDEPD1330 - A5 -- 0 | 22.20 | 3000 | 2.6 | LDEQD1330 - A5 -- 0 | 3300 pF |
| 3900 pF | | | | | 22.20 | 3000 | 1.9 | LDEPD1390 - A5 -- 0 | 22.20 | 2250 | 3.0 | LDEQD1390 - A5 -- 0 | 3900 pF |
| 4700 pF | | | | | 22.20 | 3000 | 2.0 | LDEPD1470 - A5 -- 0 | 22.20 | 2250 | 3.4 | LDEQD1470 - A5 -- 0 | 4700 pF |
| 5600 pF | | | | | 22.20 | 3000 | 2.0 | LDEPD1560 - A5 -- 0 | 22.20 | 1750 | 3.9 | LDEQD1560 - A5 -- 0 | 5600 pF |
| 6800 pF | | | | | 22.20 | 3000 | 2.3 | LDEPD1680 - A5 -- 0 | 22.20 | 1750 | 4.4 | LDEQD1680 - A5 -- 0 | 6800 pF |
| 8200 pF | | | | | 22.20 | 3000 | 2.6 | LDEPD1820 - A5 -- 0 | 28.24 | 2250 | 2.9 | LDEQE1820 - A5 -- 0 | 8200 pF |
| 0.010 μF | | | | | 22.20 | 2250 | 3.0 | LDEPD2100 - A5 -- 0 | 28.24 | 2250 | 3.4 | LDEQE2100 - A5 -- 0 | 0.010 μF |
| 0.012 μF | | | | | 22.20 | 2250 | 3.4 | LDEPD2120 - A5 -- 0 | 28.24 | 1750 | 4.0 | LDEQE2120 - A5 -- 0 | 0.012 μF |
| 0.015 μF | 22.20 | 3000 | 2.1 | LDEMD2150 - A5 -- 0 | 22.20 | 1750 | 4.0 | LDEPD2150 - A5 -- 0 | 28.24 | 1500 | 4.9 | LDEQE2150 - A5 -- 0 | 0.015 μF |
| 0.018 μF | 22.20 | 3000 | 2.2 | LDEMD2180 - A5 -- 0 | 22.20 | 1750 | 4.4 | LDEPD2180 - A5 -- 0 | 28.24 | 1500 | 5.4 | LDEQE2180 - A5 -- 0 | 0.018 μF |
| 0.022 μF | 22.20 | 3000 | 2.5 | LDEMD2220 - A5 -- 0 | 28.24 | 2250 | 3.4 | LDEPE2220 - A5 -- 0 | 40.30 | 1500 | 3.4 | LDEQF2220 - A5 -- 0 | 0.022 μF |
| 0.027 μF | 22.20 | 2250 | 2.9 | LDEMD2270 - A5 -- 0 | 28.24 | 1750 | 4.0 | LDEPE2270 - A5 -- 0 | 40.30 | 1250 | 4.0 | LDEQF2270 - A5 -- 0 | 0.027 μF |
| 0.033 μF | 22.20 | 2250 | 3.4 | LDEMD2330 - A5 -- 0 | 28.24 | 1500 | 4.7 | LDEPE2330 - A5 -- 0 | 40.30 | 1000 | 4.7 | LDEQF2330 - A5 -- 0 | 0.033 μF |
| 0.039 μF | 22.20 | 1750 | 3.8 | LDEMD2390 - A5 -- 0 | 28.24 | 1500 | 5.3 | LDEPE2390 - A5 -- 0 | 50.40 | 1500 | 3.5 | LDEQG2390 - A5 -- 0 | 0.039 μF |
| 0.047 μF | 22.20 | 1750 | 4.4 | LDEMD2470 - A5 -- 0 | 40.30 | 1500 | 3.4 | LDEPF2470 - A5 -- 0 | 50.40 | 1250 | 4.1 | LDEQG2470 - A5 -- 0 | 0.047 μF |
| 0.056 μF | 28.24 | 2250 | 3.5 | LDEME2560 - A5 -- 0 | 40.30 | 1250 | 3.9 | LDEPF2560 - A5 -- 0 | 50.40 | 1000 | 4.7 | LDEQG2560 - A5 -- 0 | 0.056 μF |
| 0.068 μF | 28.24 | 1750 | 4.1 | LDEME2680 - A5 -- 0 | 40.30 | 1250 | 4.5 | LDEPF2680 - A5 -- 0 | 50.40 | 1000 | 5.5 | LDEQG2680 - A5 -- 0 | 0.068 μF |
| 0.082 μF | 28.24 | 1500 | 4.7 | LDEME2820 - A5 -- 0 | 40.30 | 1000 | 5.4 | LDEPF2820 - A5 -- 0 | 60.54 | 1000 | 4.2 | LDEQH2820 - A5 -- 0 | 0.082 μF |
| 0.10 μF | 28.24 | 1500 | 5.4 | LDEME3100 - A5 -- 0 | 50.40 | 1250 | 3.9 | LDEPG3100 - A5 -- 0 | 60.54 | 750 | 4.8 | LDEQH3100 - A5 -- 0 | 0.10 μF |
| | | | | | 40.30 | 1000 | 5.5 | *LDEPF3100 - A0 -- 0 | | | | | |
| 0.12 μF | 40.30 | 1500 | 3.6 | LDEMF3120 - A5 -- 0 | 50.40 | 1250 | 4.4 | LDEPG3120 - A5 -- 0 | | | | | 0.12 μF |
| 0.15 μF | 40.30 | 1250 | 4.4 | LDEMF3150 - A5 -- 0 | 50.40 | 1000 | 5.3 | LDEPG3150 - A5 -- 0 | | | | | 0.15 μF |
| 0.18 μF | 40.30 | 1000 | 5.1 | LDEMF3180 - A5 -- 0 | 60.54 | 1000 | 4.2 | LDEPH3180 - A5 -- 0 | | | | | 0.18 μF |
| 0.22 μF | 50.40 | 1250 | 3.8 | LDEMG3220 - A5 -- 0 | 60.54 | 750 | 4.9 | LDEPH3220 - A5 -- 0 | | | | | 0.22 μF |
| 0.27 μF | 50.40 | 1000 | 4.7 | LDEMG3270 - A5 -- 0 | 60.54 | 750 | 5.7 | *LDEPH3270 - A5 -- 0 | | | | | 0.27 μF |
| 0.33 μF | 50.40 | 1000 | 5.6 | LDEMG3330 - A5 -- 0 | | | | | | | | | 0.33 μF |
| 0.39 μF | 60.54 | 1000 | 4.2 | LDEMH3390 - A5 -- 0 | | | | | | | | | 0.39 μF |
| 0.47 μF | 60.54 | 750 | 4.8 | LDEMH3470 - A5 -- 0 | | | | | | | | | 0.47 μF |

Tolerance - Standard: K = ±10%; M = ±20%;
 (J = ±5% available upon request and review of project/application)
 Packaging - N = Taped; A to Z = Special;
 Internal use

* only K and M tolerances available

↑
ITU Compliance

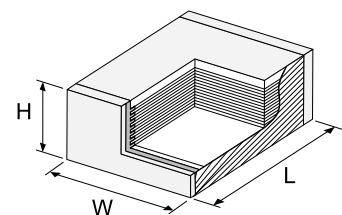

| Size code | 22.20 | 28.24 | 40.30 | 50.40 | 60.54 |
|-----------|-----------|-----------|------------|------------|------------|
| L (mm) | 6.0 ± 0.3 | 7.3 ± 0.4 | 10.5 ± 0.4 | 13.0 ± 0.4 | 15.5 ± 0.4 |
| W (mm) | 5.0 ± 0.4 | 6.1 ± 0.4 | 7.9 ± 0.5 | 10.4 ± 0.5 | 13.7 ± 0.5 |

LDE series - PEN dielectric RoHS 6 - technical data

| | |
|-------------------|--|
| Plates | Aluminium layer deposited by evaporation under vacuum. |
| Winding | Non inductive - Stacked technology. |
| Terminations | Four layers: aluminium, brass, nickel, pure tin. |
| Marking | On packaging only. |
| Climatic category | 55 / 125 / 56 |

Electrical data

| | |
|------------------------------------|---|
| Operating temperature range | -55 to +125 °C |
| Rated voltage (V _R) | 50 - 63 - 100 - 250 - 400 - 630 - 1000 V _{DC} |
| Category voltage (V _C) | V _C = V _R up to 105 °C. For temperatures between 105 and 125 °C a decreasing factor of 1.25% per degree °C has to be applied on the rated voltage (D.C. and A.C.) |
| Size range | 12.06 to 60.54 |
| Capacitance range | 1000 pF to 4.7 µF |
| Capacitance values | E12 series |
| Capacitance tolerances | Standard: K = ± 10 % M = ± 20 %; (J = ±5% available upon request and review of project/application) |
| Dissipation factor (tgδ) | ≤ 0.8 % (T = 25 ± 5 °C; f = 1 kHz) |
| Dielectric absorption | 0.8% |
| Insulation resistance | ≥ 1 GΩ for C ≤ 0.33 µF ≥ 400 s for C > 0.33 µF Test conditions: T = 25 ± 5 °C; charging time: 1 min. Charging voltage: 10 V _{DC} for V _R < 100 V _{DC} 100 V _{DC} for V _R ≥ 100 V _{DC} |
| Surge voltage test | 1.4 x V _R (2 s; T = 25 ± 5 °C) for V _R ≤ 630 V _{DC} 1.5 x V _R (2 s; T = 25 ± 5 °C) for V _R = 1000 V _{DC} |
| Maximum dv / dt | 100 V / µs for V _R ≤ 630 V _{DC} 300 V / µs for V _R = 1000 V _{DC} |

Dissipation (A.C. applications)

When a capacitor is used in A.C. applications at high frequency, the consequent internal heating may cause the risk of smoke or fire. This is due to the high current flowing through the capacitor's Equivalent Series Resistance.

The formula to calculate the maximum power [W] dissipated by the capacitor is the following:

$$P_{C \max} = \sum_{i=1}^N V_{rms_i}^2 * 2\pi f_i * C * tg\delta_{\max}(f_i) = \sum_{i=1}^N \frac{I_{rms_i}^2}{2\pi f_i * C} * tg\delta_{\max}(f_i)$$

(N: number of significant harmonics)

The formula to calculate the maximum power [W] that can be dissipated by the capacitor is the following:

$$P_{C \lim} = \frac{\Delta T_{\lim}}{R_{th}}$$

It must be: P_{Cmax} ≤ P_{Clim}

Please refer to the table and graph below for ΔT_{lim} and R_{th} values

(T_h: maximum ambient temperature surrounding the capacitor or hottest contact point - i.e. tracks - whichever is higher, in the worst operating conditions in °C)

Tests and performances

| | |
|--|--|
| Damp heat (40°C/93% R.H.; 56 days) | ΔC/C ≤ 7%; Δtgδ ≤ 50 x 10 ⁻⁴ ; IR ≥ 50% of the limit value |
| Endurance (125 °C; 2000 h; 1.25 x V _C) | ΔC/C ≤ 5%; Δtgδ ≤ 50 x 10 ⁻⁴ ; IR ≥ 50% of the limit value |
| Rapid change of temperature (1h at -55 °C; 1h at +125 °C; 1000 cycles) | ΔC/C ≤ 5% Δtgδ ≤ 50 x 10 ⁻⁴ IR ≥ limit value No mechanical damage |
| Reflow (as per reflow recommendations, see page 14) | ΔC/C ≤ 3% Δtgδ ≤ 50 x 10 ⁻⁴ IR ≥ limit value No mechanical damage |
| Bending (1 to 6 mm deflection) | ΔC/C ≤ 1% No visible damage on the terminations (peeling) neither on the body (cracking) |
| Long term stability (2 years) | ΔC/C ≤ 3% for sizes ≤ 22.20 ΔC/C ≤ 2% for sizes > 22.20 |
| Reliability (REF MIL HDBK 217) | Failure rate ≤ 1 Fit 1 Fit = 10 ⁻⁹ failures / (components * hours) |

| Size | 12.06 | 12.10 | 18.12 | 22.20 | 28.24 | | | | | |
|------------------------|-------|-------|-------|-------|-------|-----|-------|-----|-----|-----|
| H _{max} [mm] | 1.2 | 2.1 | 1.7 | 2.6 | 2.3 | 3.3 | 4.4 | 3.5 | 4.5 | 5.4 |
| R _{th} [°C/W] | 175 | 165 | 157 | 151 | 135 | 128 | 122 | 114 | 108 | 103 |
| Size | 40.30 | | | 50.40 | | | 60.54 | | | |
| H _{max} [mm] | 3.6 | 4.5 | 5.5 | 3.6 | 4.5 | 5.7 | 3.6 | 4.5 | 5.7 | |
| R _{th} [°C/W] | 93 | 88 | 84 | 75 | 70 | 66 | 58 | 55 | 52 | |

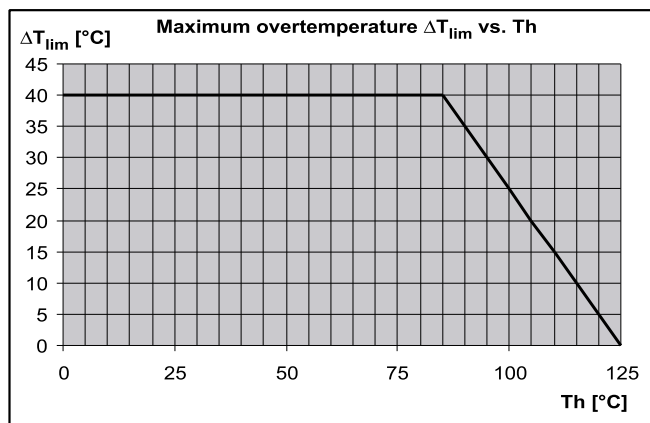

LDE Series - PEN dielectric RoHS 6

MAXIMUM V_{RMS} and I_{RMS} vs. frequency (50 - 63 - 100 - 250 V_{DC} rated voltage)

(Sinusoidal wave form / $T_h^* \leq 85^\circ C$)

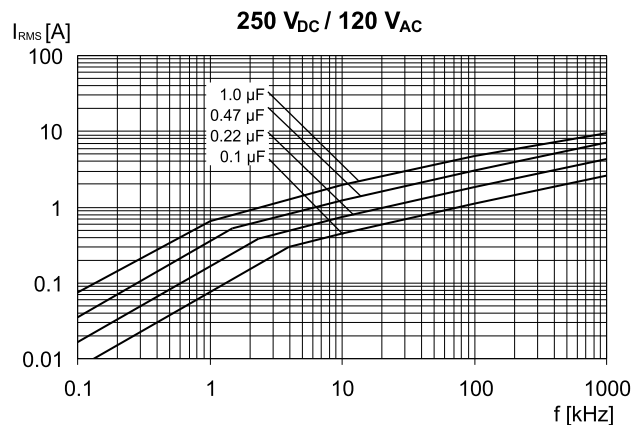
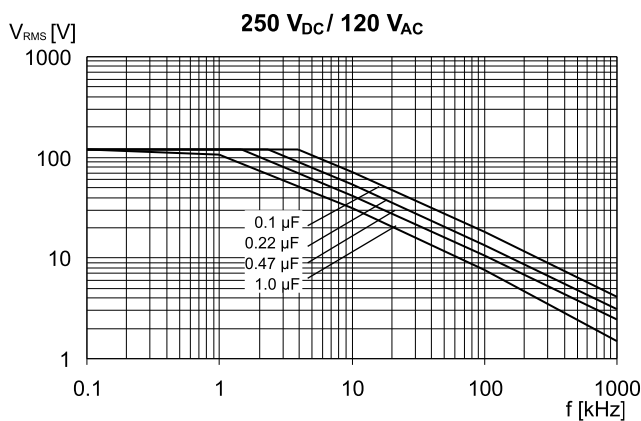
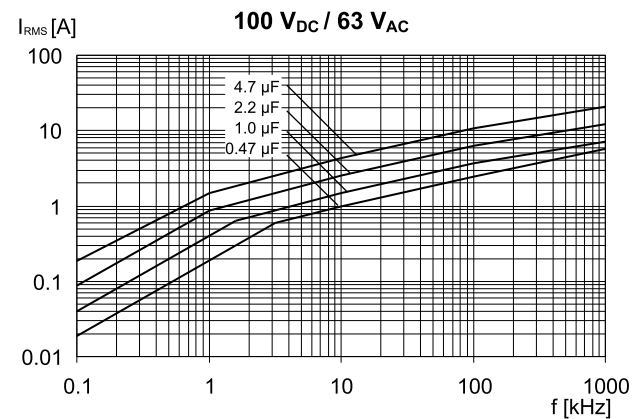
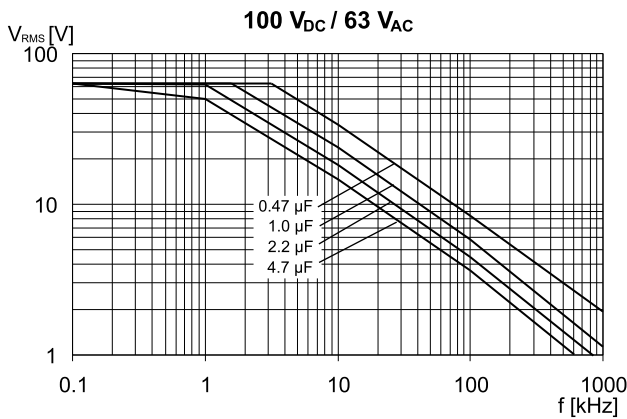
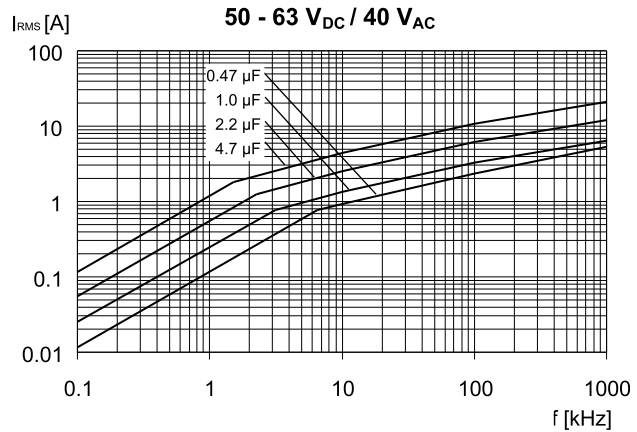
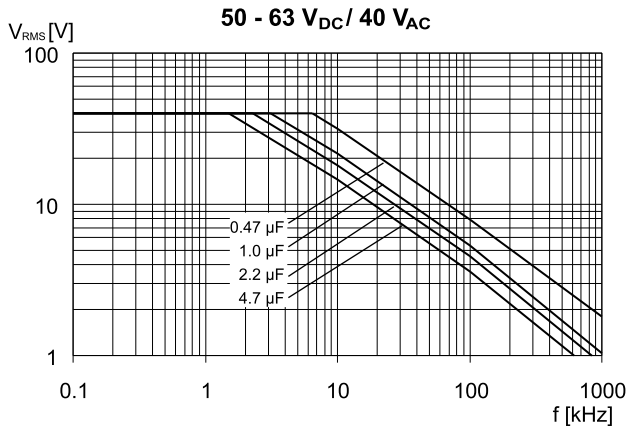

Note: measurements performed in free air condition

* T_h : maximum ambient temperature surrounding the capacitor or hottest contact point - i.e. tracks - whichever is higher, in the worst operating conditions in $^\circ C$

LDE Series - PEN dielectric RoHS 6

MAXIMUM V_{RMS} and I_{RMS} vs. frequency (400 - 630 - 1000 V_{DC} rated voltage)

(Sinusoidal wave form / $T_h^* \leq 85^\circ C$)

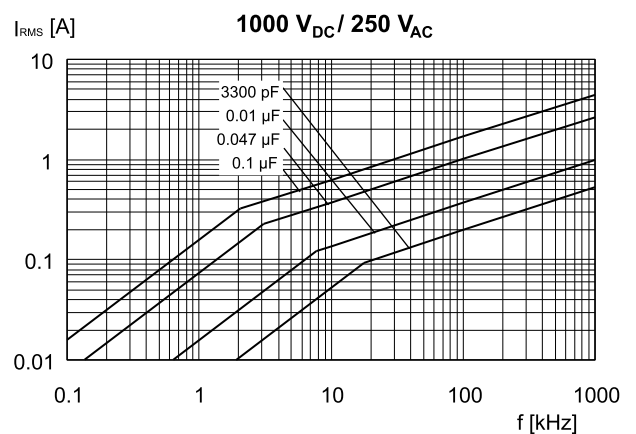
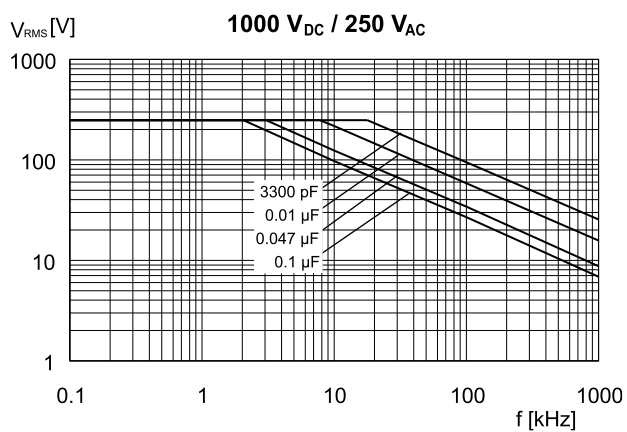
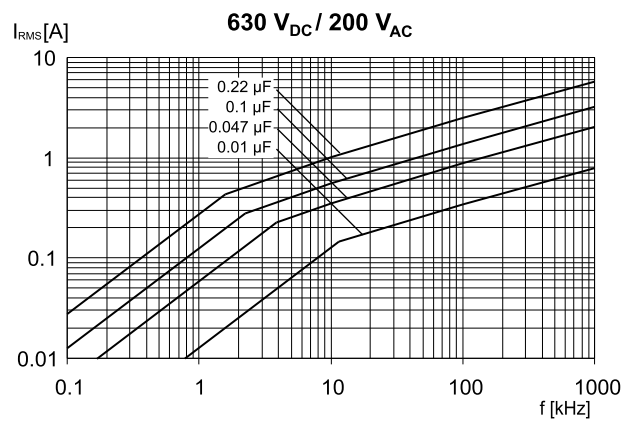
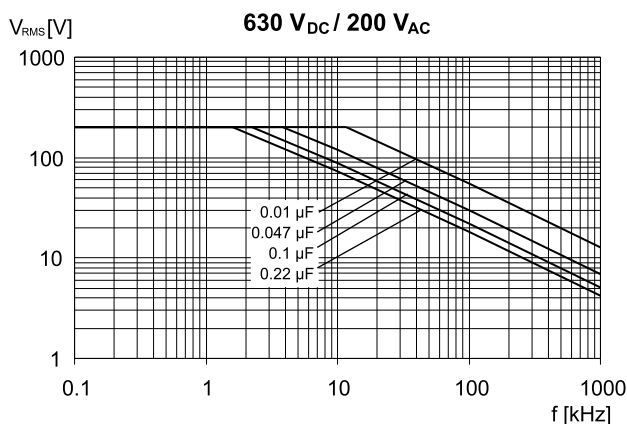
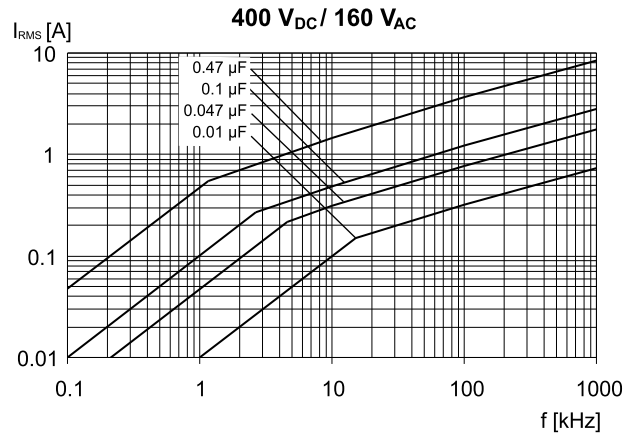
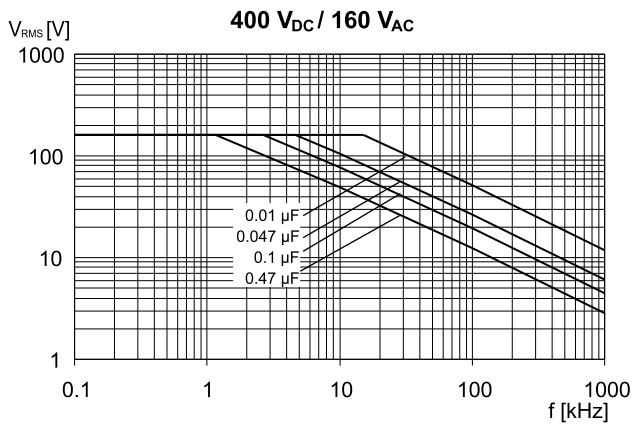

Note: measurements performed in free air condition

* T_h : maximum ambient temperature surrounding the capacitor or hottest contact point - i.e. tracks - whichever is higher, in the worst operating conditions in $^\circ C$

LDB Series - PPS dielectric RoHS 6



Standard version

| Rated capacitance | 16 V _{DC} | | | | 50 V _{DC} | | | | Rated capacitance |
|-------------------|--------------------|--------------|-----------------------|-------------------|--------------------|--------------|-----------------------|-------------------|-------------------|
| | Size code | Pcs per reel | H _{max} [mm] | Part number | Size code | Pcs per reel | H _{max} [mm] | Part number | |
| 3300 pF | | | | | 12.06 | 3000 | 1.1 | LDBCA1330 - C5 -- | 3300 pF |
| 3900 pF | | | | | 12.06 | 3000 | 1.1 | LDBCA1390 - C5 -- | 3900 pF |
| 4700 pF | | | | | 12.06 | 3000 | 1.1 | LDBCA1470 - C5 -- | 4700 pF |
| 5600 pF | | | | | 12.06 | 3000 | 1.1 | LDBCA1560 - C5 -- | 5600 pF |
| 6800 pF | | | | | 12.06 | 3000 | 1.1 | LDBCA1680 - C5 -- | 6800 pF |
| 8200 pF | | | | | 12.06 | 3000 | 1.1 | LDBCA1820 - C5 -- | 8200 pF |
| 0.010 μF | | | | | 12.06 | 3000 | 1.1 | LDBCA2100 - C5 -- | 0.010 μF |
| 0.012 μF | 12.06 | 3000 | 1.1 | LDBAA2120 - C5 -- | 12.06 | 3000 | 1.1 | LDBCA2120 - C5 -- | 0.012 μF |
| 0.015 μF | 12.06 | 3000 | 1.1 | LDBAA2150 - C5 -- | 12.10 | 2250 | 1.4 | LDBCB2150 - C5 -- | 0.015 μF |
| 0.018 μF | 12.06 | 3000 | 1.1 | LDBAA2180 - C5 -- | 12.10 | 2250 | 1.5 | LDBCB2180 - C5 -- | 0.018 μF |
| 0.022 μF | 12.06 | 3000 | 1.1 | LDBAA2220 - C5 -- | 12.10 | 2250 | 1.5 | LDBCB2220 - C5 -- | 0.022 μF |
| 0.027 μF | 12.06 | 3000 | 1.1 | LDBAA2270 - C5 -- | 12.10 | 2250 | 1.5 | LDBCB2270 - C5 -- | 0.027 μF |
| 0.033 μF | 12.06 | 3000 | 1.1 | LDBAA2330 - C5 -- | 12.10 | 2250 | 1.7 | LDBCB2330 - C5 -- | 0.033 μF |
| 0.039 μF | 12.06 | 3000 | 1.2 | LDBAA2390 - C5 -- | 12.10 | 2250 | 1.9 | LDBCB2390 - C5 -- | 0.039 μF |
| 0.047 μF | 12.06 | 3000 | 1.3 | LDBAA2470 - C5 -- | 12.10 | 2250 | 2.3 | LDBCB2470 - C5 -- | 0.047 μF |
| 0.056 μF | 12.10 | 2250 | 1.7 | LDBAB2560 - C5 -- | 18.12 | 4000 | 1.7 | LDBCC2560 - C5 -- | 0.056 μF |
| 0.068 μF | 12.10 | 2250 | 1.7 | LDBAB2680 - C5 -- | 18.12 | 4000 | 1.7 | LDBCC2680 - C5 -- | 0.068 μF |
| 0.082 μF | 12.10 | 2250 | 1.7 | LDBAB2820 - C5 -- | 18.12 | 4000 | 1.7 | LDBCC2820 - C5 -- | 0.082 μF |
| 0.10 μF | 12.10 | 2250 | 2.0 | LDBAB3100 - C5 -- | 18.12 | 3000 | 2.0 | LDBCC3100 - C5 -- | 0.10 μF |

Tolerance - G = ±2%; J = ±5%;
 Packaging - N = Taped; A to Z = Special;
 Internal use _____

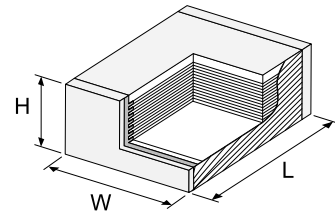

| Size code | 12.06 | 12.10 | 18.12 |
|-----------|-------------------------------------|-------------------------------------|-------------------------------------|
| L (mm) | 3.3 ^{+0.3} _{-0.1} | 3.3 ^{+0.3} _{-0.1} | 4.7 ^{+0.3} _{-0.2} |
| W (mm) | 1.7 ± 0.2 | 2.5 ± 0.3 | 3.3 ± 0.3 |

LDB Series - PPS dielectric RoHS 6 - technical data

| | |
|-------------------|--|
| Plates | Aluminium layer deposited by evaporation under vacuum. |
| Winding | Non inductive - Stacked technology. |
| Terminations | Four layers: aluminium, brass, nickel, pure tin. |
| Marking | On packaging only. |
| Climatic category | 55 / 125 / 56 |

Electrical data

| | |
|-----------------------------------|--|
| Operating temperature range | -55 to + 125 °C |
| Rated voltage (V_R) | 16 - 50 V_{DC} |
| Category voltage (V_C) | $V_C = V_R$ up to 105 °C. For temperatures between 105 and 125 °C a decreasing factor of 1.25 % per degree °C has to be applied on the D.C. rated voltage |
| Size range | 12.06 to 18.12 |
| Capacitance range | 3300 pF to 0.1 μ F |
| Capacitance values | E12 series |
| Capacitance tolerances | ± 2 % (G); ± 5 % (J) |
| Dissipation factor ($tg\delta$) | ≤ 0.6 % ($T = 25 \pm 5$ °C; $f = 1$ kHz) |
| Dielectric absorption | 0.02% |
| Insulation resistance | ≥ 3 G Ω Test conditions: $T = 25 \pm 5$ °C; charging time: 1 min. Charging voltage: 10 V_{DC} for $V_R = 16$ V_{DC} 50 V_{DC} for $V_R = 50$ V_{DC} |
| Surge voltage test | $1.75 \times V_R$ (5 s; $T = 25 \pm 5$ °C) |

Tests and performances

| | |
|---|--|
| Damp heat (40 °C / 93% R.H.; 56 days) | $ \Delta C/C \leq 5\%$; $ \Delta tg\delta \leq 30 \times 10^{-4}$; IR $\geq 50\%$ of the limit value |
| Endurance (125 °C; 2000 h; $1.25 \times V_C$) | $ \Delta C/C \leq 3\%$; $ \Delta tg\delta \leq 30 \times 10^{-4}$; IR $\geq 50\%$ of the limit value |
| Rapid change of temperature (1h at -55 °C; 1h at +125 °C; 1000 cycles) | $ \Delta C/C \leq 3\%$ $ \Delta tg\delta \leq 50 \times 10^{-4}$ IR \geq limit value No mechanical damage |
| Reflow (as per reflow recommendations, see page 14) | $ \Delta C/C \leq 3\%$; $ \Delta tg\delta \leq 50 \times 10^{-4}$; IR \geq limit value No mechanical damage |
| Bending (1 to 6 mm deflection) | $ \Delta C/C \leq 1\%$ No visible damage on the terminations (peeling) neither on the body (cracking) |
| Long term stability (2 years) | $ \Delta C/C \leq 1\%$ |
| Reliability (REF. MIL HDBK 217) | Failure rate ≤ 1 Fit 1 Fit = 10^{-9} failures / (components * hours) |

Soldering recommendations and cautions

Reflow recommendations

Preheating

Maximum preheating time: 180 s
 Minimum temperature: 150 °C
 Maximum temperature: 200 °C

Maximum time within T_{max} and $T_{max} - 5\text{ °C}$ (ΔT_5):

40 s ($T_{max} \leq 250\text{ °C}$)
 10 s ($250\text{ °C} < T_{max} \leq 255\text{ °C}^*$)

Maximum time over 217 °C (ΔT_{217}): 150 s

Maximum temperature on the component's body (T_{max}):

| Capacitor H_{max} [mm] | Capacitor volume [mm ³] | | |
|-----------------------------|-------------------------------------|------------|----------|
| | < 350 | 350 - 2000 | > 2000 |
| < 1.6 | 255 °C * | 255 °C * | 255 °C * |
| 1.6 - 2.5 | 255 °C * | 250 °C | 245 °C |
| > 2.5 | 250 °C | 245 °C | 245 °C |

Maximum temperature ramp rate:

3 °C / s (heating)
 6 °C / s (cooling)

Second reflow

if two reflow processes are needed, be sure that, before the second reflow, the temperature on the capacitor's surface is lower than 50 °C.

in line with JEDEC STD 020C ed. July 2004 with some limitations * For LDB series this value is 260 °C.

Reflow temperature profile

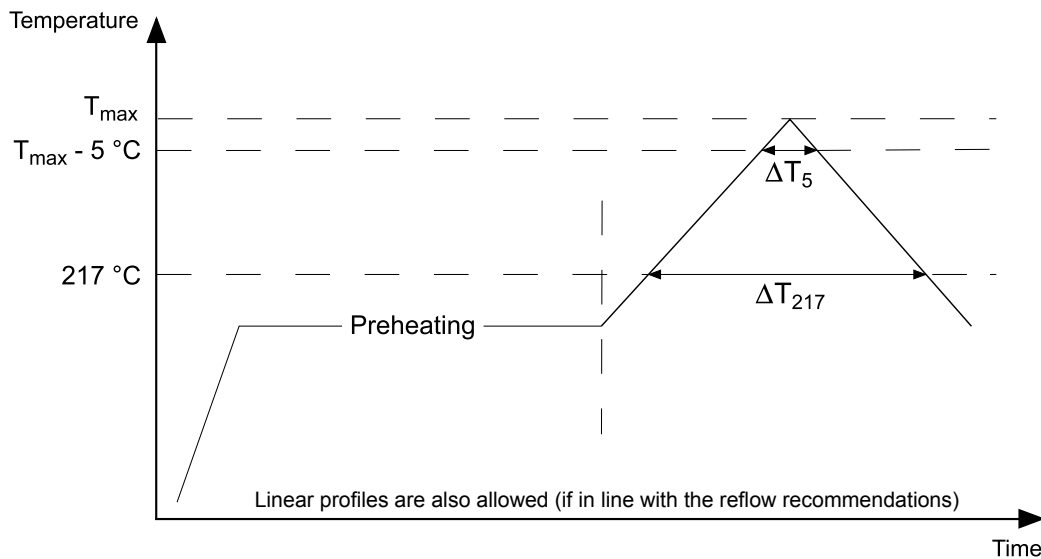

Landing areas and solder paste suggestions

| Size | A [mm] | B [mm] | C [mm] | D [mm] |
|-------|--------|--------|--------|--------|
| 12.06 | 1.5 | 1.1 | 2.3 | 4.5 |
| 12.10 | 2.3 | 1.1 | 2.3 | 4.5 |
| 18.12 | 3.0 | 1.7 | 3.1 | 6.5 |
| 22.20 | 4.6 | 2.1 | 3.9 | 8.1 |
| 28.24 | 5.7 | 2.3 | 5.3 | 9.9 |
| 40.30 | 7.4 | 2.6 | 8.2 | 13.4 |
| 50.40 | 9.6 | 2.6 | 10.7 | 15.9 |
| 60.54 | 12.6 | 2.6 | 13.2 | 18.4 |

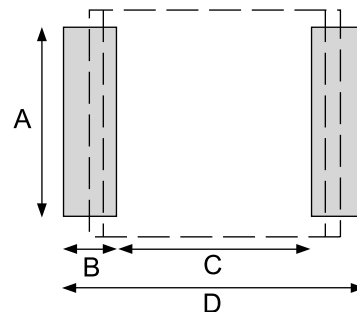

These new landing area dimensions have the aim of taking full advantage of the new RoHS 6 terminations design.

We suggest to use a Sn / Ag / Cu solder paste (suggested thickness: 0.10 ÷ 0.15 mm).

The preceding layout (2004 Catalogue) is therefore to be considered still valid, although not optimal for RoHS 6.

If a NOT Lead Free solder paste is used, a minimum peak temperature of 210 °C on the component's body is suggested.

Soldering recommendations and cautions

Flux / Cleaning / Storage and Moisture

Flux suggestions

We suggest to use a no-clean flux with a halogen content lower than 0.1%.

Cleaning suggestions

To clean the PCB assembly we suggest to use a suitable solvent like Isopropyl Alcohol, deionized water or neutral pH detergents. Solvents like Toluene, Xylene and Trichloroethylene should not be used.

Storage and moisture recommendations

Arcotronics SMD Film Capacitors are supplied in a MBB (Moisture Barrier Bag) Class 1. We can guarantee a 24 months minimum shelf life (temperature $\leq 40\text{ }^{\circ}\text{C}$ / relative humidity $\leq 90\%$).

After the MBB has been opened, components may stay in areas with controlled temperature and humidity (temperature $\leq 30\text{ }^{\circ}\text{C}$ / relative humidity $\leq 60\%$) for 168 hours (rated voltage $\leq 100\text{ V}_{\text{DC}}$) or 696 hours (rated voltage $> 100\text{ V}_{\text{DC}}$).

For longer periods of time and / or higher temperature and / or higher relative humidity values, it is absolutely necessary to protect the components against humidity. If the reel inside the MBB is partially used, Arcotronics recommends to re-use the same MBB or to avoid areas without controlled temperature and humidity (see above). If the above conditions are not respected, components require a baking (minimum time: 48 hours at $55 \pm 5\text{ }^{\circ}\text{C}$) before the reflow.

Manual assembly recommendations

If PCBs are assembled manually, care must be taken to avoid any mechanical damage to the components.

Our recommendations are the following (see Fig. 1):

- 1) when using tweezers, the components should be gripped across the two terminations (A);
- 2) avoid any contact with the two cutting surfaces (C);
- 3) a vacuum pen is recommended on the top and bottom surfaces (B).

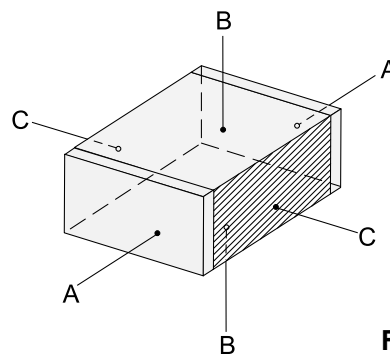

Fig. 1

Manual soldering recommendations

LDE and LDB series have been designed for Surface Mount Technology, pick & place machines and reflow soldering systems. Using a manual soldering iron, issues may occur because the typical temperature for manual soldering is around $350\text{ }^{\circ}\text{C}$. Therefore please pay careful attention:

- never touch the capacitor body with the soldering iron but rather touch the soldering iron and the end termination with the tin wire edge (see Fig. 2);
- if the soldering iron is equipped with a temperature controller device: set the temperature to $250 \pm 3\text{ }^{\circ}\text{C}$ and proceed as per Fig. 2 (the maximum soldering time, on both terminations, is 5 s);
- if the soldering iron is NOT equipped with a temperature controller device: this is the worst situation. The following are a few practical suggestions but, clearly, the operator's experience is extremely important:
 - 1) proceed as per Fig. 2;
 - 2) as soon as the tin wire starts melting, move the soldering iron away as quickly as possible;
 - 3) wait a few seconds and check that the soldering joint has been properly created;
- if the soldering iron is equipped with a hot air flow device: set the hot air temperature to $250 \pm 3\text{ }^{\circ}\text{C}$ and do not send the hot air directly onto the capacitor plastic body. In this situation, the operator's experience is very important;
- in any case, avoid mass-mounting SMD Film Capacitors manually.

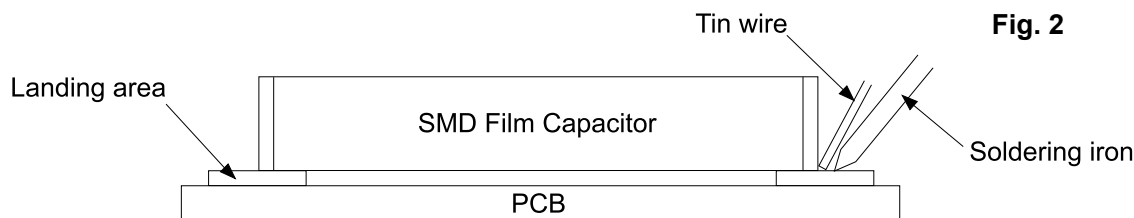

Fig. 2

Production process basic suggestions

| In case of: | Typical cause | Typical solution |
|--|---|---|
| no solder joint on one end termination | landing area dimensions | see landing areas suggestions, page 14 |
| | solder paste quality | see solder paste suggestions, page 14 |
| | not-uniform solder paste thickness on the landing areas | set the dispensing solder paste machine properly |
| | wrong position of the capacitor on the landing areas | set the pick & place machine properly |
| | thermal profile parameters | see reflow recommendations, page 14 |
| | bad temperature distribution in the reflow oven | check the reflow oven temperature distribution and variations |
| no solder joint on both end terminations | landing area dimensions | see landing areas suggestions, page 14 |
| | solder paste quality | see solder paste suggestions, page 14 |
| | no solder paste on the landing areas | set the dispensing solder paste machine properly |
| | thermal profile parameters | see reflow recommendations, page 14 |
| | bad temperature distribution in the reflow oven | check the reflow oven temperature distribution and variations |
| | oxidated end terminations | see moisture recommendations, page 15 |
| capacitor's body mechanical deformation | too long time over 217 °C | see reflow recommendations, page 14 |
| | too long time within T_{max} and $T_{max} - 5$ °C | see reflow recommendations, page 14 |
| | too high temperature ramp rate | see reflow recommendations, page 14 |
| | capacitor damaged by a soldering iron | see manual soldering recommendations, page 15 |
| capacitance drop (up to 20%) | too long time over 217 °C | see reflow recommendations, page 14 |
| | too long time within T_{max} and $T_{max} - 5$ °C | see reflow recommendations, page 14 |
| | too high temperature ramp-up rate | see reflow recommendations, page 14 |
| | capacitor damaged by a soldering iron | see manual soldering recommendations, page 15 |
| capacitance drop (over 20%) | capacitor damaged by a soldering iron | see manual soldering recommendations, page 15 |

Note: small fissures on the capacitor's cutting surface are actually slight detachments of two adjacent metallized film layers and have to be considered only as an aesthetic issue related to the SMD Film Capacitors' manufacturing process and technology.

Therefore, small fissures on SMD Film Capacitors are not comparable to cracks on SMD Ceramics.

Fissures do not influence in anyway SMD Film Capacitors' reliability.